

# PF-7000



## ■Features

- 1.No electrical equipment required since it utilizes inexpensive steam pressure or air pressure for operation.
- 2.Maintenance inspection is easily done due to main parts are attached to the cover.
- 3.No manpower required
- 4.Running costs can be significantly reduced since gas for the operation is consumed only at the time of pumping.

## ■Specifications

Model		PF-7000
Nominal size	25A (Condensate inlet: 25A / Condensate outlet: 25A)	
	40A (Condensate inlet: 40A / Condensate outlet: 40A)	
	50A (Condensate inlet: 50A / Condensate outlet: 50A)	
	80A (Condensate inlet: 80A / Condensate outlet: 50A)	
Application		Steam condensate, Non-hazardous fluid
Motive fluid		Steam / Air
Max. motive pressure		0.8 MPa *1
Max. working temperature		180°C
Material	Body	Ductile cast iron (FCD450)
	Trim parts	Stainless steel
	Float (P)	Stainless steel
Connection		JIS Rc screwed
Check valve at inlet and outlet side		Externally attached *2

\*1 The most appropriate value of motive pressure is back pressure at outlet + 0.1 to 0.2 MPa.

\*2 Install check valve (SCV-2 or SCV-3) on inlet and outlet side of the product.

## ■Dimensions (mm) and Weights (kg)

Nominal size	d <sub>1</sub>	d <sub>2</sub>	L	Weight
25A	Rc 1	Rc 1	544	92
40A	Rc 1-1/2	Rc 1-1/2	549	92
50A	Rc 2	Rc 2	525	91
80A	Rc 3	Rc 2	500	90

Motive fluid port	Vent port
Rc 1/2	Rc 1

\* Bush is attached at condensate inlet for the product of size 50A.

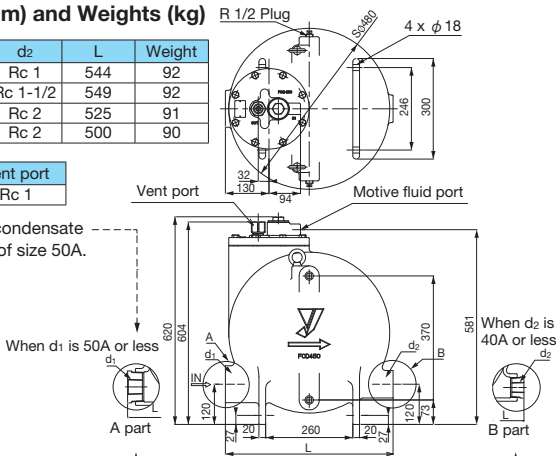

\* Bush is attached at condensate inlet and outlet for size 25A and 40A.

## ■Option

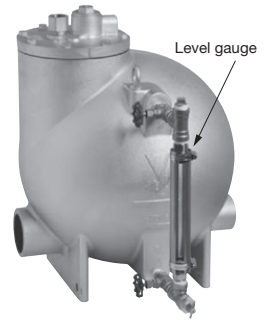

## ■Maintenance Space

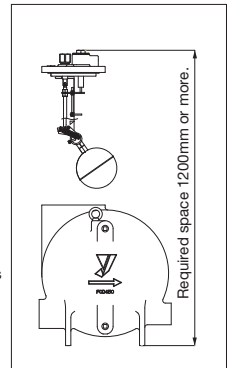

**Flow Rate**

<Motive fluid: steam>

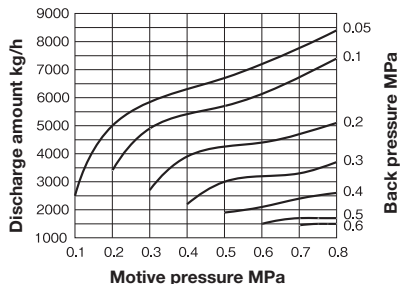

<Motive fluid: air>

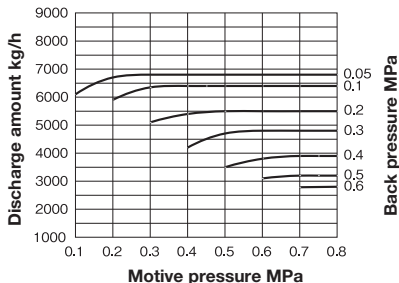

\* Flow rate described above indicates condensate volume when condensate flow-in height (P2) is 1,000 mm above the bottom of the product.

**Flow Rate Correction Coefficient (Piping Example)**

- Discharge capacity varies depending on condensate flow-in-height. Multiply the volume by the following factors according to condensate flow-in height (P2).
- Condensate flow-in height means the level above the bottom of the product.

- Discharge capacity varies depending on size of condensate inlet and outlet. Multiply the volume by the following factors according to the size.

Motive fluid	Condensate flow-in height [mm]			
	800	1000	1200	1400
Steam	0.85	1.00	1.05	1.15
Air	0.85	1.00	1.15	1.30

Motive fluid	Size (Condensate inlet-outlet)			
	80A-50A	50A-50A	40A-40A	25A-25A
Steam	1.00	0.90	0.70	0.35
Air	1.00	0.95	0.70	0.30

<Open system>

Pumping trap is that the condensate from receiver tank pumped to the condensate recovery pipe by operation of steam pressure or air pressure.

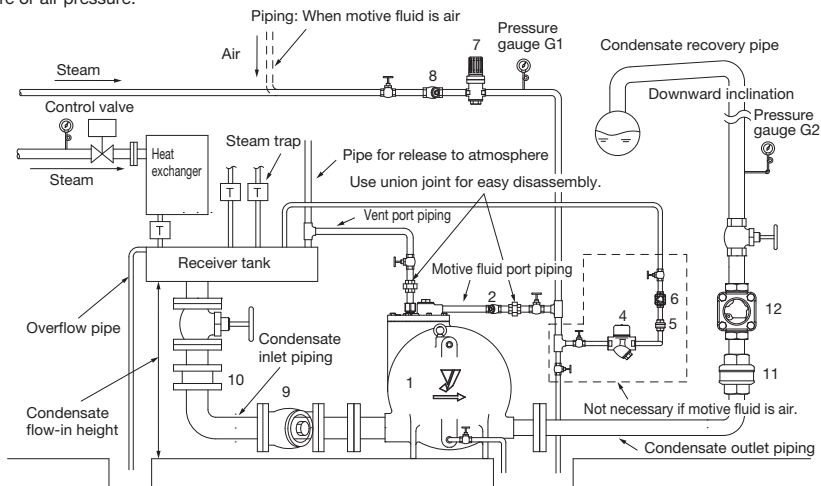

No.	Name	No.	Name	No.	Name
1	Pumping trap	4	Steam trap	6, 12	Sight glass
2, 8, 9	Strainer	5, 10, 11	Check valve	7	Pressure reducing valve

**Guidelines for Pumping Trap**



**Installation of receiver tank**

Receiver tank is used for separation of flash steam and condensate, condensate temporary storage, protection of pumping trap, etc. Be sure to install receiver tank before using pumping trap.

**Sizing of open receiver (open system)**

Open receiver tank requires capacity to store condensate when pumping trap works and discharges condensate. Also, flash steam and condensate flows inside the condensate pipe at the same time, open receiver tank separates condensate from flash steam, and send only the condensate into the pumping trap. Therefore, open receiver tank requires dimensions enough to separate flash steam and condensate.

- 1) Calculate flash steam amount
  - 1 Calculate flash steam ratio from usage condition, using the chart for condensate flash rate.
 

Ex) Condensate discharged from steam trap used in steam pressure 0.8 MPa to open receiver (atmospheric pressure), from the chart 1, flashes approximately 14%.
  - 2 Calculate flash steam amount from condensate amount and flash rate. Flash steam Condensate amount Flash rate
 

Ex) If condensate amount is 1,000 kg/h, flash steam amount is  $1,000 \times 14/100 = 140\text{kg/h}$
- 2) Calculate diameter of receiver tank from flash steam amount.
 

(Standard length: 1 m)

Ex) From calculated flash steam amount and the chart 2, vent piping diameter is found as intermediate between 80A and 100A, then select 100A. In the same way, diameter of open receiver is 200A (length: 1 m).

**Sizing of closed receiver (closed system)**

Pumping trap requires capacity to store condensate temporarily during its operation. In relation to operation cycle, its capacity should be approximately 0.5% of condensate amount for an hour. For selection, use the chart 3.

- Ex) If condensate amount is 1,000 kg/h, from the chart 3, when diameter of receiver tank is 80A, length is 1 m. When 100A, length is 0.65 m as a guide.

**Chart 1 Flash rate of Condensate**

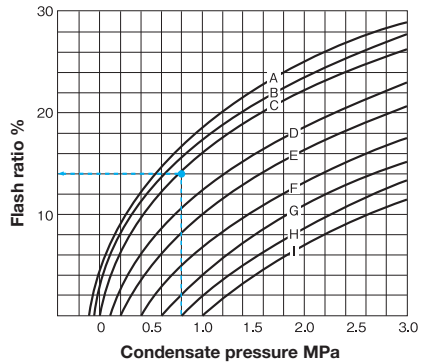

Code	A	B	C	D	E	F	G	H	I
Back pressure MPa	-0.05	-0.03	Atmospheric pressure	0.1	0.2	0.4	0.6	0.8	1.0

**Chart 2 Sizing chart of open receiver**

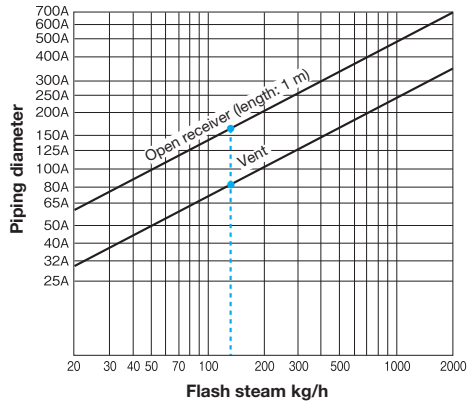

**Chart 3 Sizing chart of closed receiver**

